



SANYO Semiconductors

DATA SHEET

An ON Semiconductor Company

LV4992TT — Bi-CMOS IC For Portable Audio Equipment Stereo SE Power Amplifier

Overview

The LV4992TT is the best LSI for the speaker drive for portable equipment that is battery drive, including the power amplifier circuit capable of low voltage (from 2.7V) operation and stand-by function to reduce the consumption current.

Functions and Features

- Built-in stereo SE power amplifier
 - Output power 1= 160mW ($V_{CC} = 3.6V$, $R_L = 8\Omega$ and THD = 10%)
 - Output power 2= 340mW ($V_{CC} = 5.0V$, $R_L = 8\Omega$ and THD = 10%)
 - Output power 3= 55mW ($V_{CC} = 3.6V$, $R_L = 32\Omega$ and THD = 10%)
 - Output power 4= 110mW ($V_{CC} = 5.0V$, $R_L = 32\Omega$ and THD = 10%)
- Enabling low voltage operation : $V_{CC} =$ from 2.7V
- Standby function : (supply current in standby mode : 0.1 μ A (standard)) ($V_{CC} = 3.6V$)
- Thermal shut down circuit
- Enabling gain setting : Voltage gain (0 to 14dB)
- No capacitor for output phase compensation is necessary.

Specifications

Absolute Maximum Ratings at $T_a = 25^\circ C$

Parameter	Symbol	Conditions	Ratings	Unit
Maximum supply voltage	V_{CC} max		6	V
Allowable power dissipation	P_d max	Substrate mounted*	750	mW
Operating temperature	T_{opr}		-40 to +85	$^\circ C$
Storage temperature	T_{stg}		-40 to +150	$^\circ C$

* When mounted on the specified printed circuit board (58 × 89 × 1.6mm, glass epoxy, both side)

■ Any and all SANYO Semiconductor Co.,Ltd. products described or contained herein are, with regard to "standard application", intended for the use as general electronics equipment (home appliances, AV equipment, communication device, office equipment, industrial equipment etc.). The products mentioned herein shall not be intended for use for any "special application" (medical equipment whose purpose is to sustain life, aerospace instrument, nuclear control device, burning appliances, transportation machine, traffic signal system, safety equipment etc.) that shall require extremely high level of reliability and can directly threaten human lives in case of failure or malfunction of the product or may cause harm to human bodies, nor shall they grant any guarantee thereof. If you should intend to use our products for applications outside the standard applications of our customer who is considering such use and/or outside the scope of our intended standard applications, please consult with us prior to the intended use. If there is no consultation or inquiry before the intended use, our customer shall be solely responsible for the use.

■ Specifications of any and all SANYO Semiconductor Co.,Ltd. products described or contained herein stipulate the performance, characteristics, and functions of the described products in the independent state, and are not guarantees of the performance, characteristics, and functions of the described products as mounted in the customer's products or equipment. To verify symptoms and states that cannot be evaluated in an independent device, the customer should always evaluate and test devices mounted in the customer's products or equipment.

SANYO Semiconductor Co., Ltd.

TOKYO OFFICE Tokyo Bldg., 1-10, 1 Chome, Ueno, Taito-ku, TOKYO, 110-8534 JAPAN

LV4992TT

Operating Conditions at $T_a = 25^\circ\text{C}$

Parameter	Symbol	Conditions	Ratings	Unit
Recommended supply voltage	V_{CC}		3.6	V
Recommended load resistance	R_L		8 to 32	Ω
Operating supply voltage range	$V_{CC\text{ op}}$		2.7 to 5.5	V

Note : Please determine supply voltage used with due consideration of allowable power dissipation

Electrical Characteristics $T_a = 25^\circ\text{C}$, $V_{CC} = 3.6\text{V}$, $f_{in} = 1\text{kHz}$, $R_L = 8\Omega$

Parameter	Symbol	Conditions	Ratings			Unit
			min	typ	max	
Supply current during no signal	I_{CCOP}	No signal		2.7	4.5	mA
Standby supply current	I_{STBY}	No signal, $V_2 = \text{LOW}$		0.1	10	μA
Output power	P_{OMX}	THD = 10%	100	160		mW
Voltage gain	VG	$V_{IN} = -30\text{dBV}$	5	6.5	8	dB
Voltage gain difference	VGR		0		14	dB
Total harmonic distortion	THD	$V_{IN} = -10\text{dBV}$		0.1	1	%
Output noise voltage	V_{NOUT}	$R_g = 620\Omega$, 20 to 20kHz		65	195	μVrms
Channel separation	CHSEP	$P_O = 50\text{mW}$, $R_g = 620\Omega$ and 20 to 20kHz	50	60		dB
Ripple rejection ratio	SVRR	$R_g = 620\Omega$, $f_r = 100\text{Hz}$ and $V_r = -20\text{dBV}$		47		dB
Reference voltage (pin 3)	VREF			1.81		V
High level control voltage (pin 2)	VSTBH	Power amplifier operation mode	1.9		V_{CC}	V
Low level control voltage (pin 2)	VSTBL	Power amplifier standby mode	0		0.3	V

Package Dimensions

unit : mm (typ)

3245B

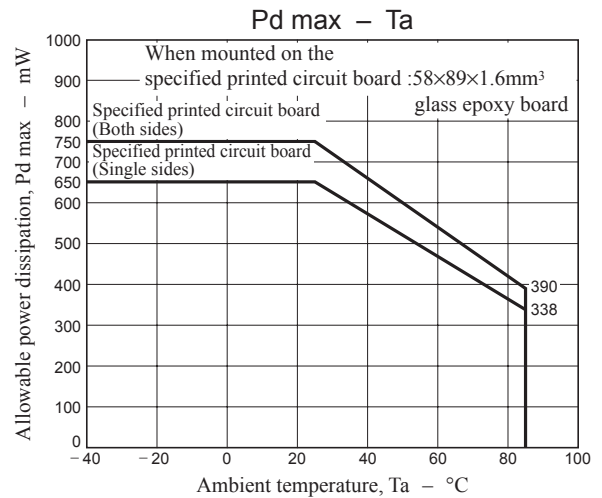
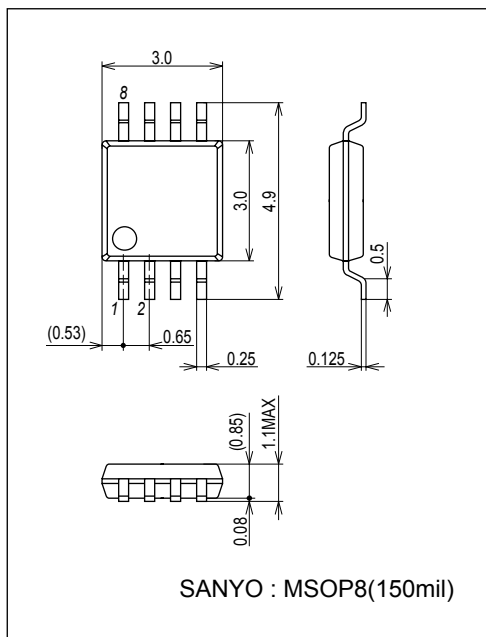

LV4992TT

Recommended Board Layout

1. Both side

Size : 58mm×89mm×1.6mm

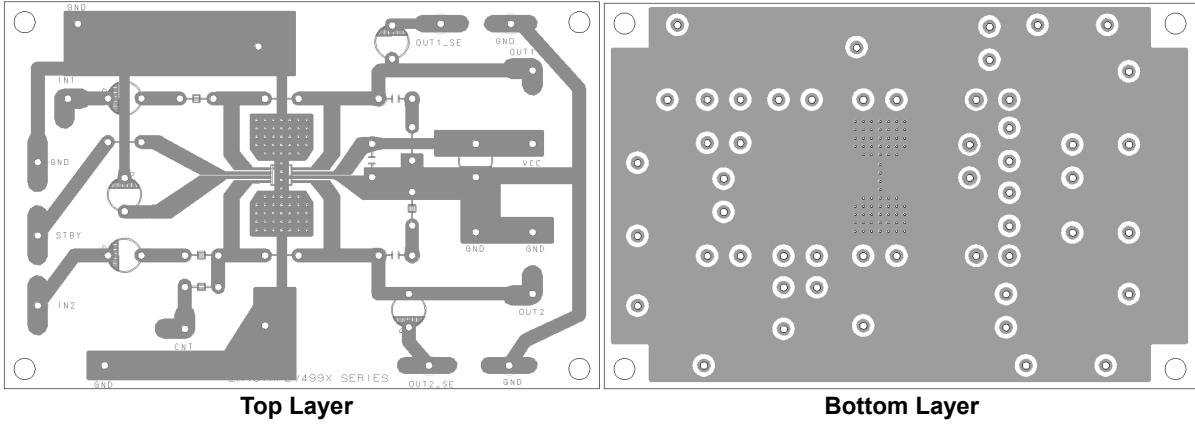

2. Single side

Size : 58mm×89mm×1.6mm

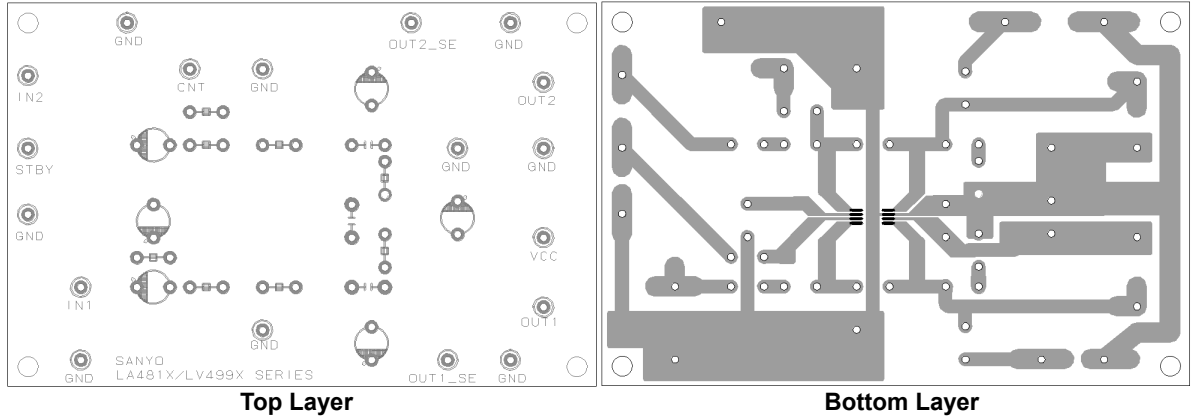

LV4992TT

Block Diagram and Sample Application Circuit

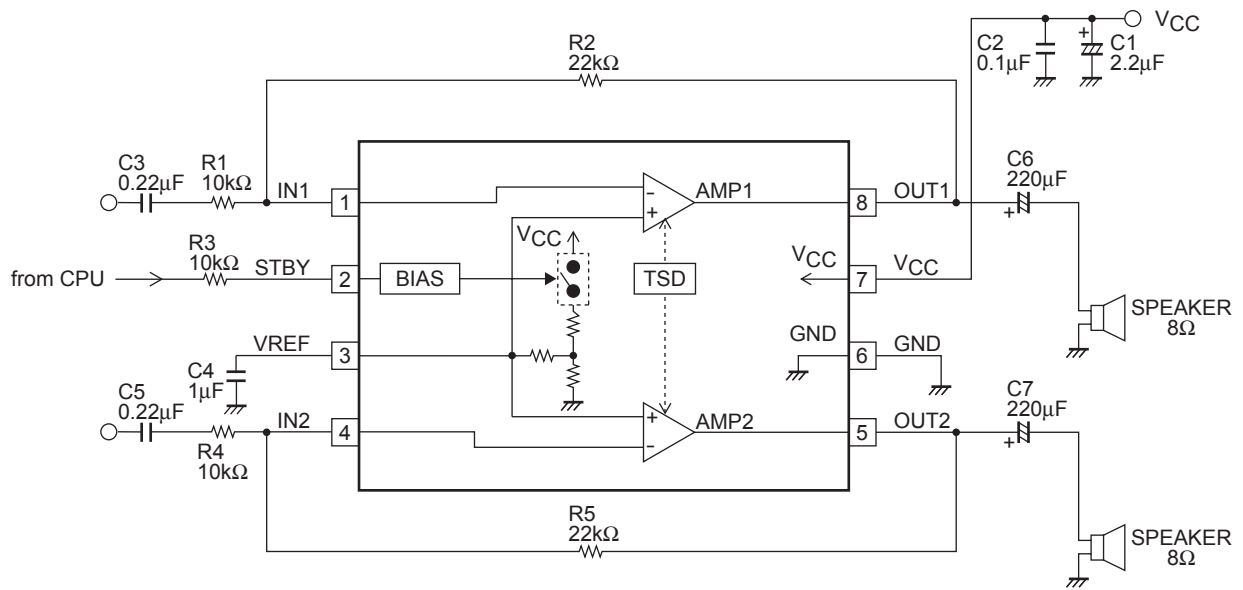

Test Circuit

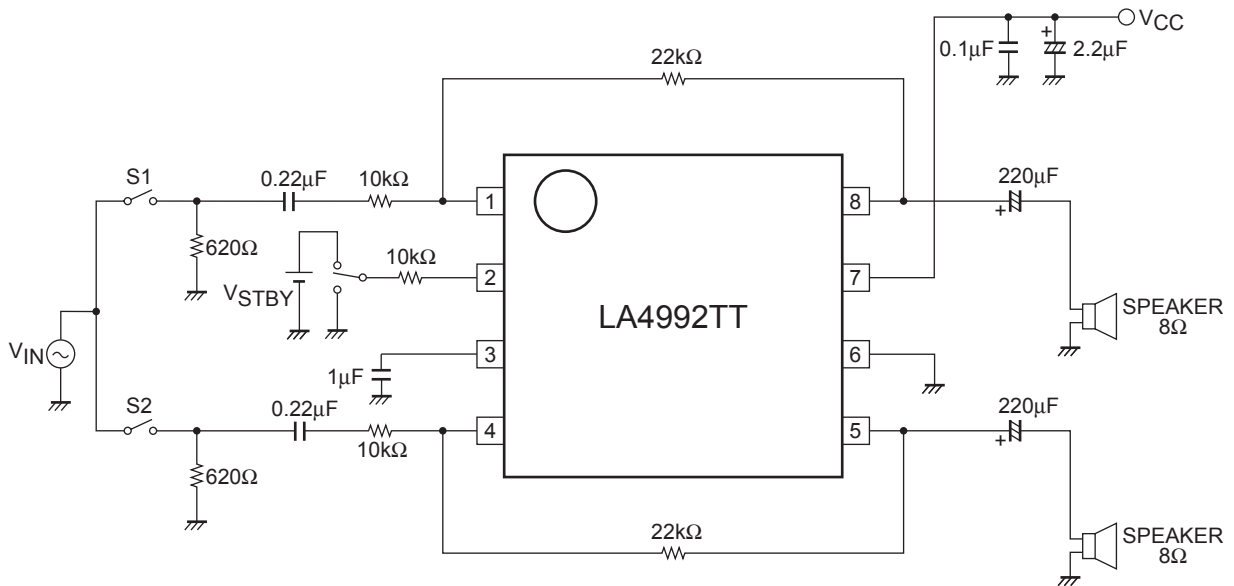

LV4992TT

Pin Function

Pin No.	Pin name	Pin voltage	Description	Equivalent circuit
		$V_{CC} = 3.6V$		
1 4	IN1 IN2	1.81	Input pin	
2	STBY		Standby pin <ul style="list-style-type: none"> •Standby mode (0 to 0.3V) •Operation mode (1.9 to V_{CC}) 	
3	VREF	1.81	Ripple filter pin (Capacity connection for filter)	
5 8	OUT2 OUT1	1.81	Power amplifier output pin	
6	GND	0	Ground pin	
7	V_{CC}	3.6	Power supply pin	

Usage Note

1. Input coupling capacitor (C3 and C5)

Since the high pass filter is formed by the input coupling capacitor C3, C5 and the input resistance R1, R4, low frequency attenuates. Therefore, it is necessary to select the capacitance value with due consideration of passband. The capacitance value influences a shock noise when the switch is turned on, caution is demanded because the level of shock noise becomes large when a bigger capacitance value is set.

2. The 3rd pin capacitor (C4)

The power supply ripple is reduced by the 3rd pin capacitor C4. The Ripple rejection ratio improves when the capacitance value is large. However, this capacitor influences the shock noise and rise time of amplifier. Please design with both characteristics in mind.

3. Standby pin (pin 2)

The standby mode and the operation mode can be switched by controlling the standby pin.

Standby mode ⇒ V2 = 0 to 0.3V

Operation mode ⇒ V2 = 1.9 to VCCV

In addition, caution is necessary since the current I_{ST} flows to the standby pin when the standby pin is used by working with power supply as shown in FIG.1.

$$I_{ST} = \frac{V_{CC} - 1.4V}{R3 + 21k\Omega} \text{ (Approximate value)}$$

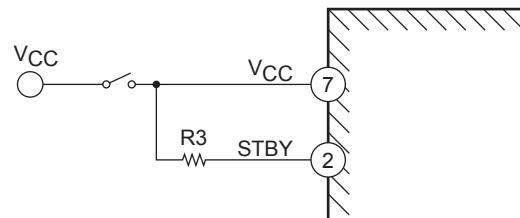

Fig. 1

4. Power supply bypass capacitor (C2)

The bypass capacitor must be inserted, as close as possible to the power supply pin (pin 7).

5. Short-circuit between terminals

Turning on the power supply with the short-circuit between terminals leads to the deterioration and destruction of IC. When fixing the IC to the substrate, please check that the solder is not short-circuited between the terminals before turning on the power.

6. Load Short-circuit

Leaving the IC in the load short-circuit for many hours leads to the deterioration and destruction of the IC. The load must not be short-circuited absolutely.

7. Maximum rating

When the rated value used is just below to the absolute maximum ratings value, there is a possibility to exceed the maximum rating value with slight extrusion variable. Also, it can be a destructive accident. Please use within the absolute maximum ratings with sufficient variation margin of supply voltage.

LV4992TT

General Characteristics

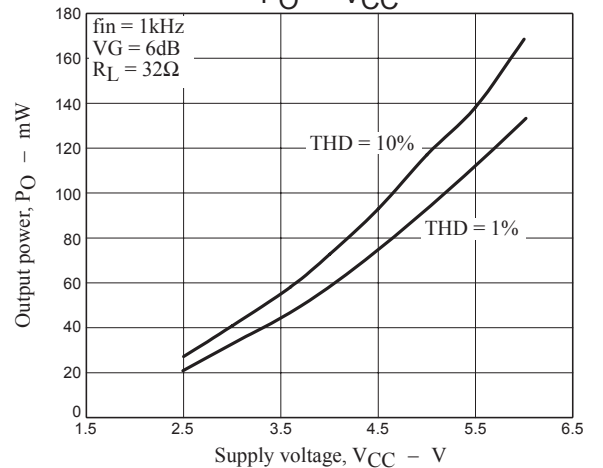
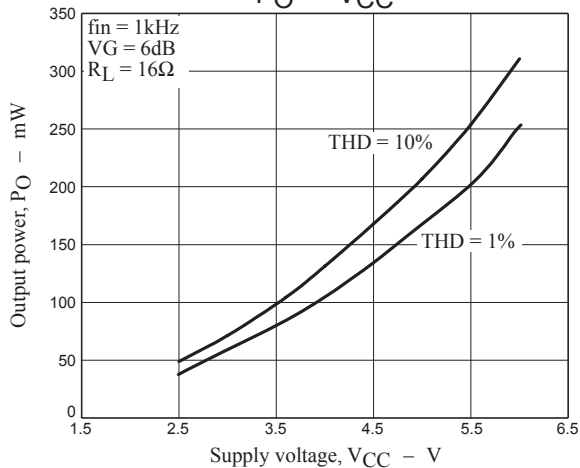
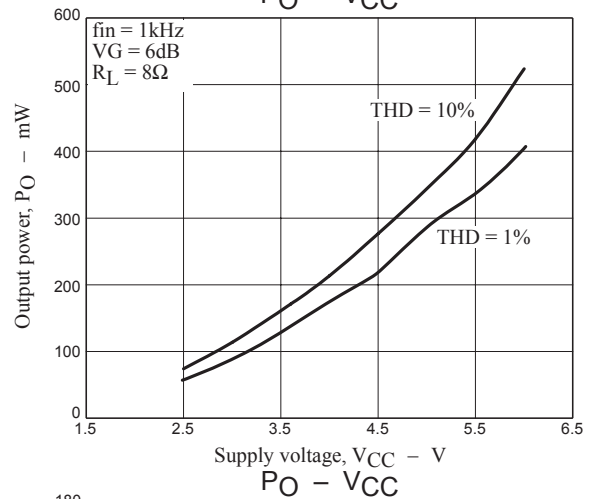
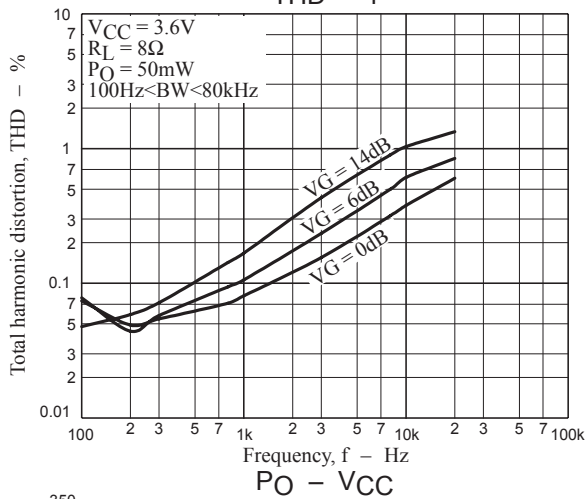
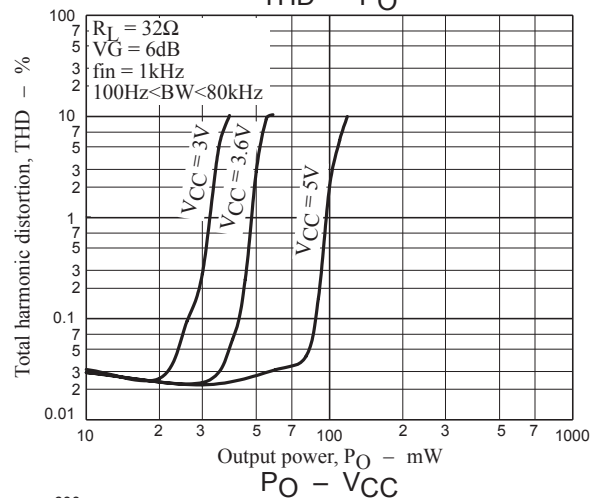
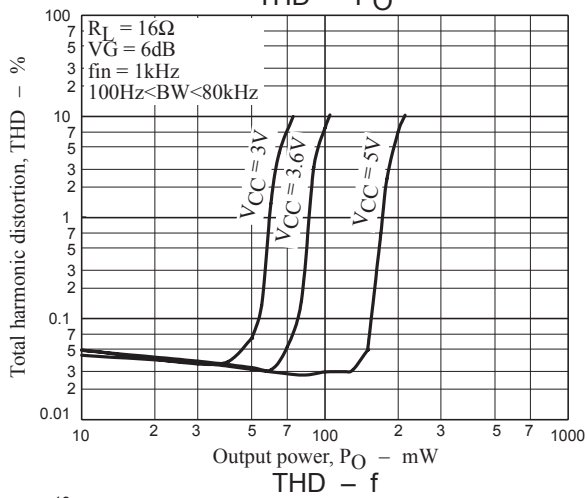
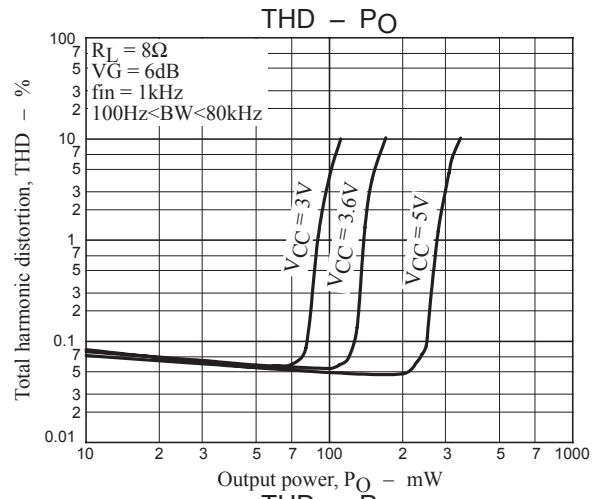
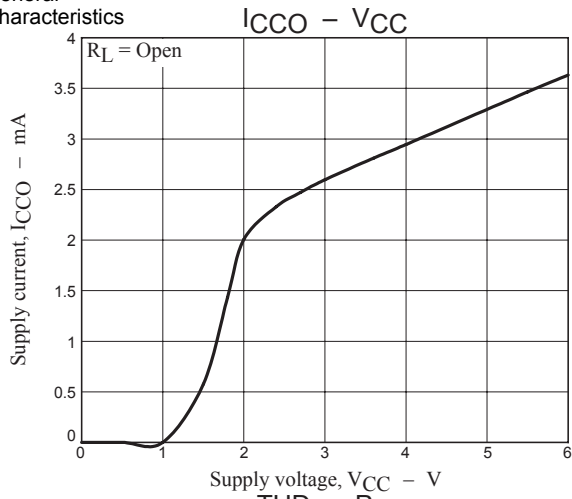

LV4992TT

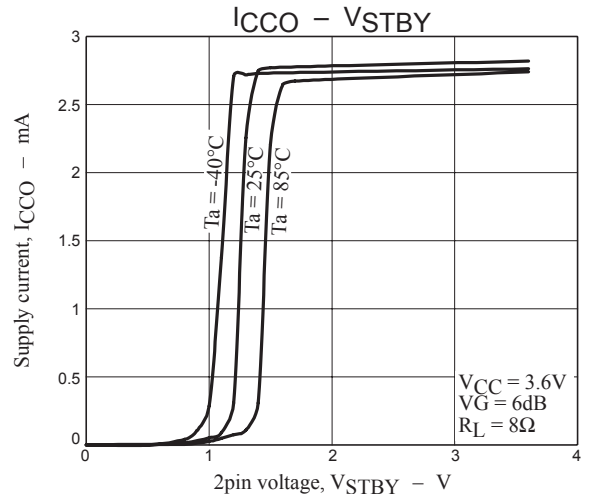
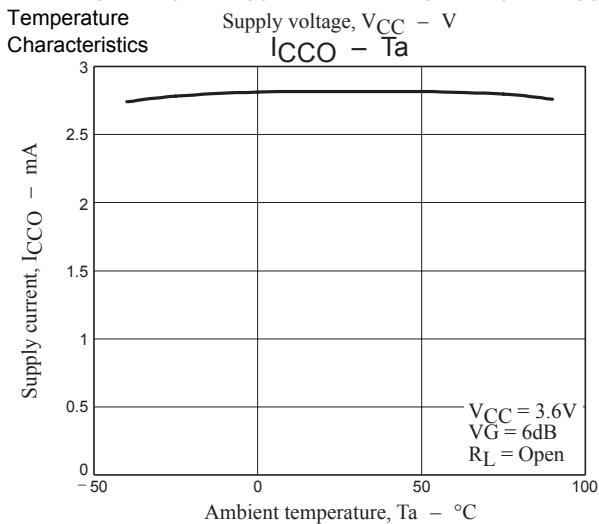
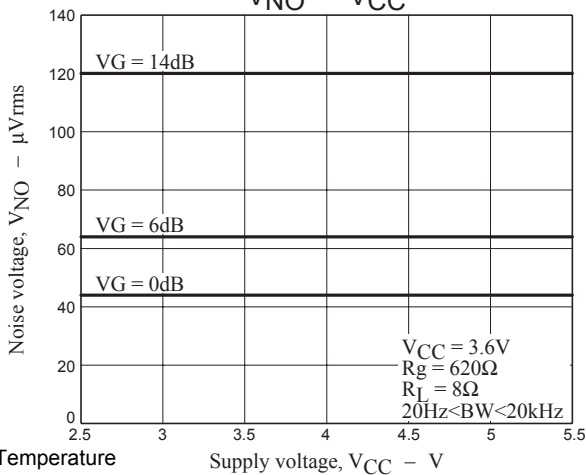
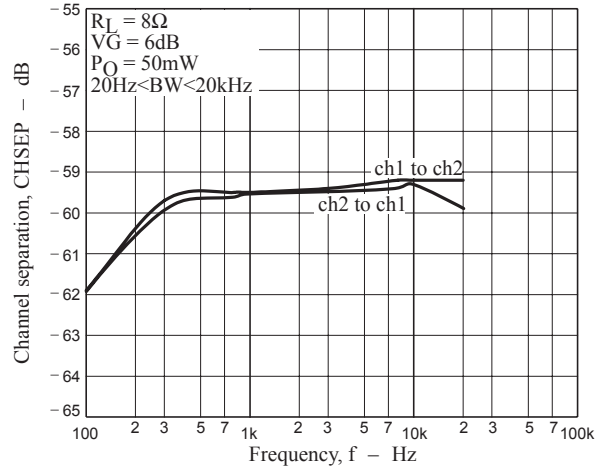
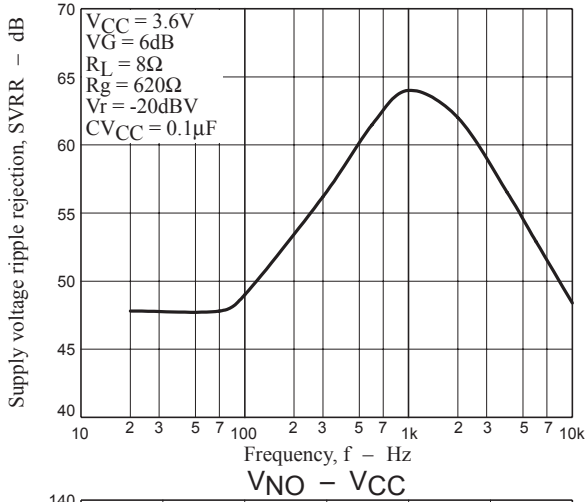
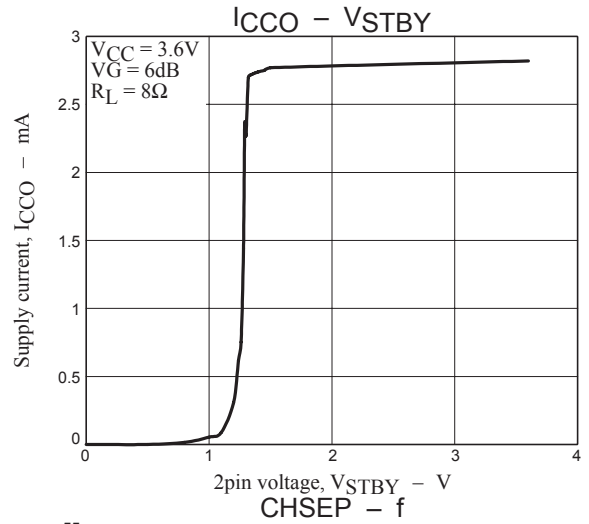
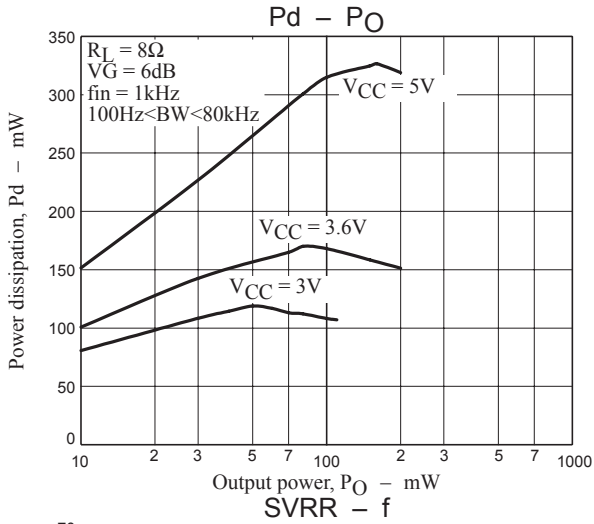

LV4992TT

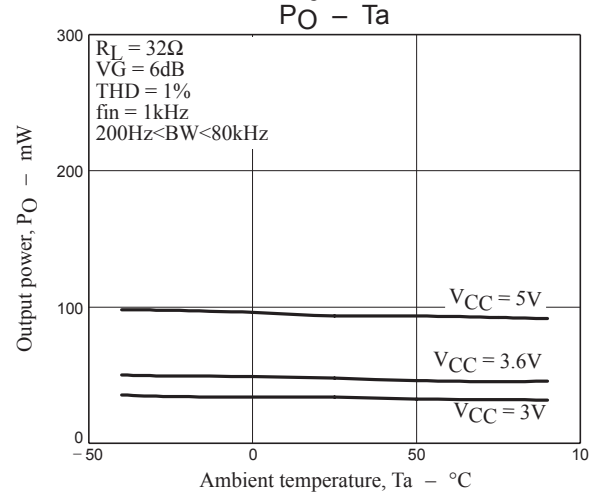
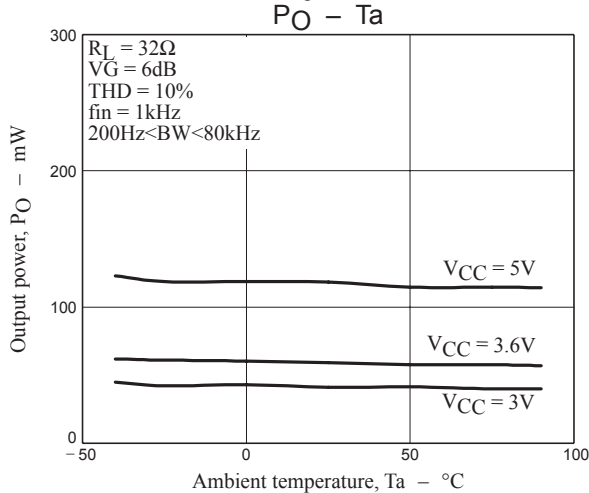
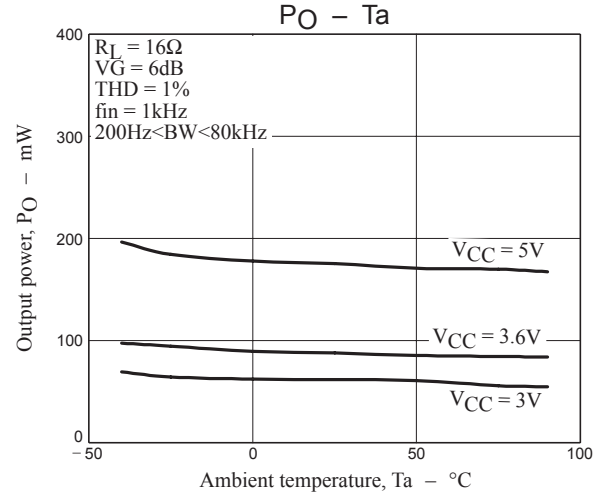
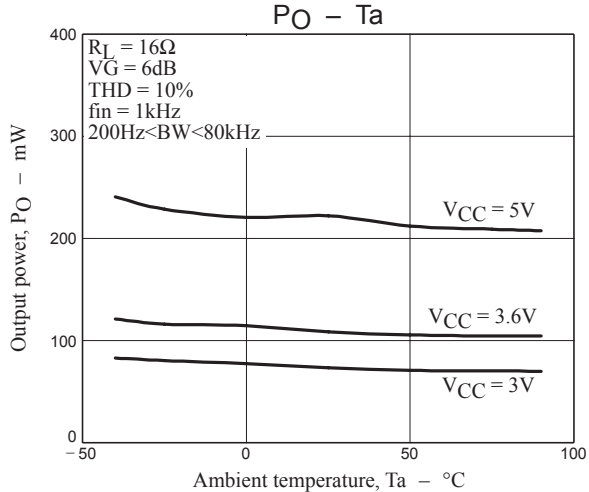
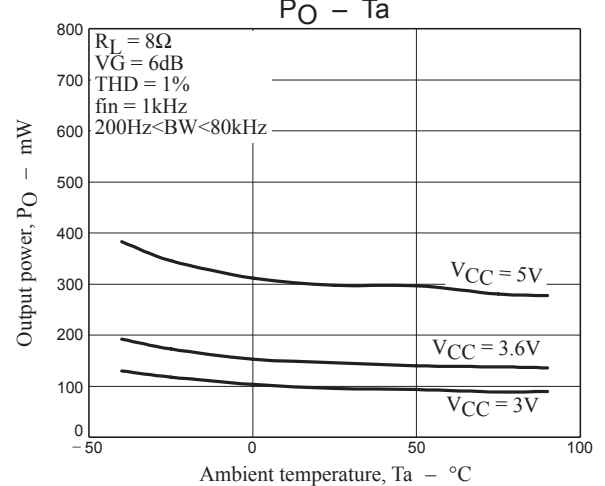
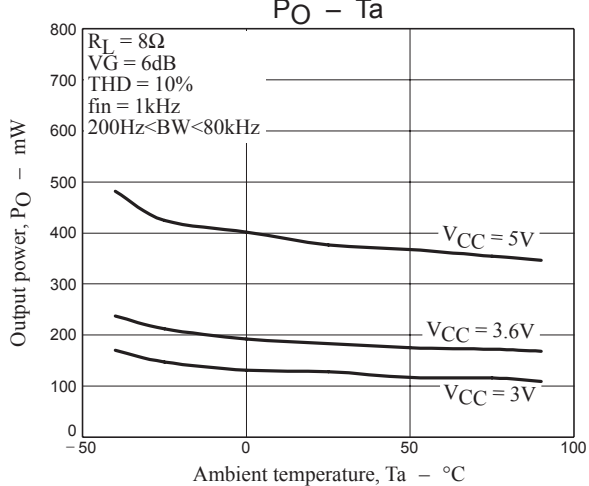
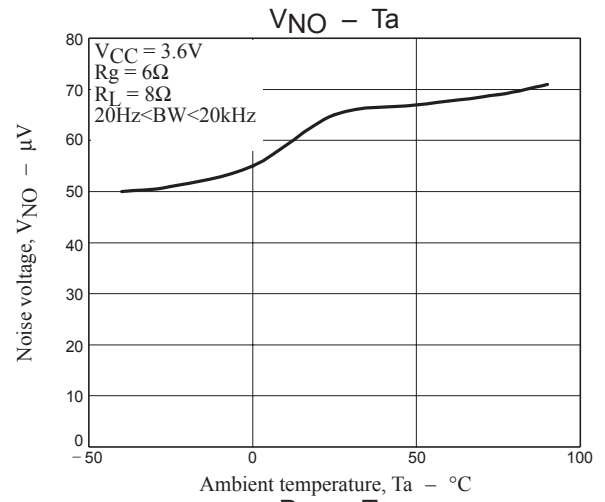
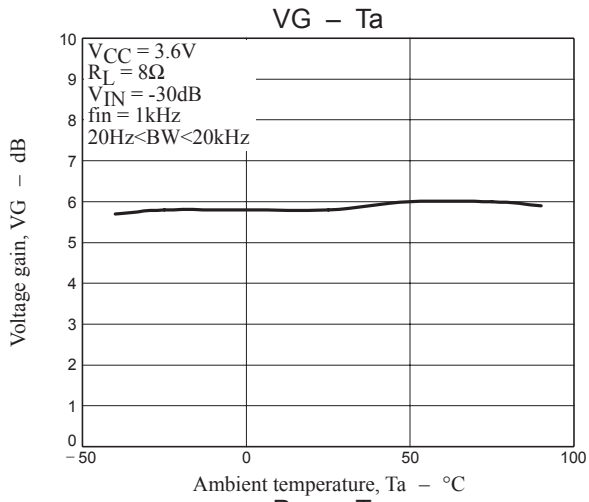

LV4992TT

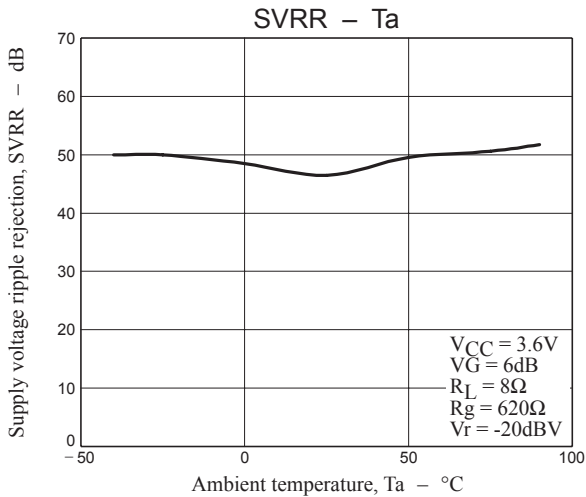

Shock Noise

1. Rising edge

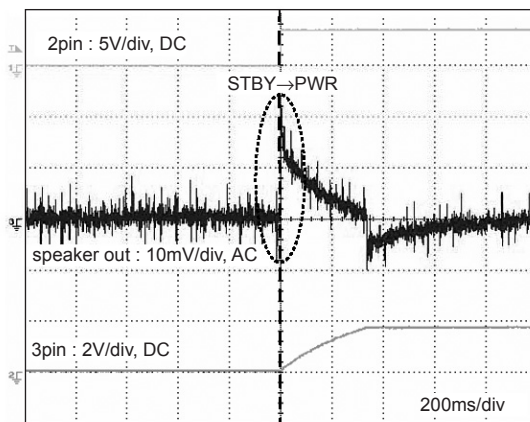

2. Falling edge

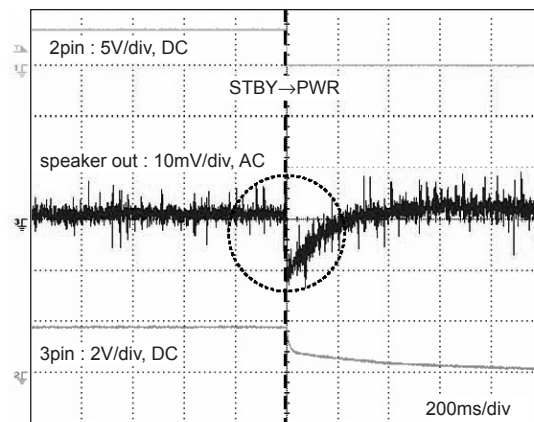

- SANYO Semiconductor Co.,Ltd. assumes no responsibility for equipment failures that result from using products at values that exceed, even momentarily, rated values (such as maximum ratings, operating condition ranges, or other parameters) listed in products specifications of any and all SANYO Semiconductor Co.,Ltd. products described or contained herein.
- SANYO Semiconductor Co.,Ltd. strives to supply high-quality high-reliability products, however, any and all semiconductor products fail or malfunction with some probability. It is possible that these probabilistic failures or malfunction could give rise to accidents or events that could endanger human lives, trouble that could give rise to smoke or fire, or accidents that could cause damage to other property. When designing equipment, adopt safety measures so that these kinds of accidents or events cannot occur. Such measures include but are not limited to protective circuits and error prevention circuits for safe design, redundant design, and structural design.
- In the event that any or all SANYO Semiconductor Co.,Ltd. products described or contained herein are controlled under any of applicable local export control laws and regulations, such products may require the export license from the authorities concerned in accordance with the above law.
- No part of this publication may be reproduced or transmitted in any form or by any means, electronic or mechanical, including photocopying and recording, or any information storage or retrieval system, or otherwise, without the prior written consent of SANYO Semiconductor Co.,Ltd.
- Any and all information described or contained herein are subject to change without notice due to product/technology improvement, etc. When designing equipment, refer to the "Delivery Specification" for the SANYO Semiconductor Co.,Ltd. product that you intend to use.
- Information (including circuit diagrams and circuit parameters) herein is for example only; it is not guaranteed for volume production.
- Upon using the technical information or products described herein, neither warranty nor license shall be granted with regard to intellectual property rights or any other rights of SANYO Semiconductor Co.,Ltd. or any third party. SANYO Semiconductor Co.,Ltd. shall not be liable for any claim or suits with regard to a third party's intellectual property rights which has resulted from the use of the technical information and products mentioned above.

This catalog provides information as of September, 2007. Specifications and information herein are subject to change without notice.